

MC14013B

Dual Type D Flip-Flop

The MC14013B dual type D flip-flop is constructed with MOS P-channel and N-channel enhancement mode devices in a single monolithic structure. Each flip-flop has independent Data, (D), Direct Set, (S), Direct Reset, (R), and Clock (C) inputs and complementary outputs (Q and \bar{Q}). These devices may be used as shift register elements or as type T flip-flops for counter and toggle applications.

Features

- Static Operation
- Diode Protection on All Inputs
- Supply Voltage Range = 3.0 Vdc to 18 Vdc
- Logic Edge-Clocked Flip-Flop Design
- Logic state is retained indefinitely with clock level either high or low; information is transferred to the output only on the positive-going edge of the clock pulse
- Capable of Driving Two Low-power TTL Loads or One Low-power Schottky TTL Load Over the Rated Temperature Range
- Pin-for-Pin Replacement for CD4013B
- These Devices are Pb-Free, Halogen Free and are RoHS Compliant
- NLV Prefix for Automotive and Other Applications Requiring Unique Site and Control Change Requirements; AEC-Q100 Qualified and PPAP Capable

MAXIMUM RATINGS (Voltages Referenced to V_{SS})

| Symbol | Parameter | Value | Unit |
|-------------------|---|------------------------|--------------------|
| V_{DD} | DC Supply Voltage Range | -0.5 to +18.0 | V |
| V_{in}, V_{out} | Input or Output Voltage Range (DC or Transient) | -0.5 to $V_{DD} + 0.5$ | V |
| I_{in}, I_{out} | Input or Output Current (DC or Transient) per Pin | ± 10 | mA |
| P_D | Power Dissipation, per Package (Note 1) | 500 | mW |
| T_A | Ambient Temperature Range | -55 to +125 | $^{\circ}\text{C}$ |
| T_{stg} | Storage Temperature Range | -65 to +150 | $^{\circ}\text{C}$ |
| T_L | Lead Temperature (8-Second Soldering) | 260 | $^{\circ}\text{C}$ |

Stresses exceeding Maximum Ratings may damage the device. Maximum Ratings are stress ratings only. Functional operation above the Recommended Operating Conditions is not implied. Extended exposure to stresses above the Recommended Operating Conditions may affect device reliability.

1. Temperature Derating:

Plastic "P and D/DW" Packages: - 7.0 mW/ $^{\circ}\text{C}$ From 65 $^{\circ}\text{C}$ To 125 $^{\circ}\text{C}$

This device contains protection circuitry to guard against damage due to high static voltages or electric fields. However, precautions must be taken to avoid applications of any voltage higher than maximum rated voltages to this high-impedance circuit. For proper operation, V_{in} and V_{out} should be constrained to the range $V_{SS} \leq (V_{in} \text{ or } V_{out}) \leq V_{DD}$.

Unused inputs must always be tied to an appropriate logic voltage level (e.g., either V_{SS} or V_{DD}). Unused outputs must be left open.



ON Semiconductor®

<http://onsemi.com>

MARKING DIAGRAMS

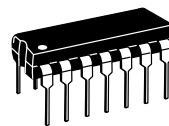

PDIP-14
P SUFFIX
CASE 646

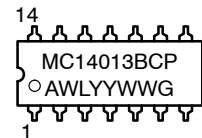

SOIC-14
D SUFFIX
CASE 751A

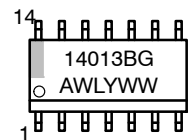

TSSOP-14
DT SUFFIX
CASE 948G

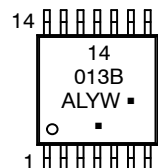

SOEIAJ-14
F SUFFIX
CASE 965

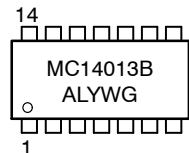

- A = Assembly Location
- WL, L = Wafer Lot
- YY, Y = Year
- WW, W = Work Week
- G or ■ = Pb-Free Package



(Note: Microdot may be in either location)

ORDERING INFORMATION

See detailed ordering and shipping information in the package dimensions section on page 2 of this data sheet.

MC14013B

TRUTH TABLE

| Inputs | | | | Outputs | |
|---|------|-------|-----|---------|-----------|
| Clock [†] | Data | Reset | Set | Q | \bar{Q} |
|  | 0 | 0 | 0 | 0 | 1 |
|  | 1 | 0 | 0 | 1 | 0 |
|  | X | 0 | 0 | Q | \bar{Q} |
| X | X | 1 | 0 | 0 | 1 |
| X | X | 0 | 1 | 1 | 0 |
| X | X | 1 | 1 | 1 | 1 |

No
Change

X = Don't Care
† = Level Change

PIN ASSIGNMENT

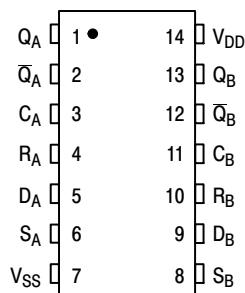

BLOCK DIAGRAM

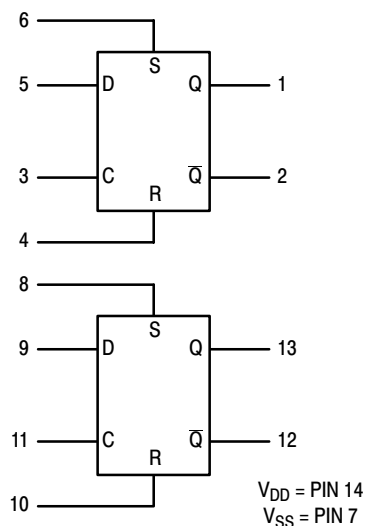

ORDERING INFORMATION

| Device | Package | Shipping [†] |
|-----------------|------------------------|--------------------------|
| MC14013BCPG | PDIP-14 (Pb-Free) | 25 Units / Rail |
| NLV14013BCPG* | | |
| MC14013BDG | SOIC-14 (Pb-Free) | 55 Units / Rail |
| NLV14013BDG* | | |
| MC14013BDR2G | SOIC-14 (Pb-Free) | 2500 Units / Tape & Reel |
| NLV14013BDR2G* | | |
| MC14013BDTR2G | TSSOP-14 (Pb-Free) | |
| NLV14013BDTR2G* | | |
| MC14013BFG | SOEIAJ-14 (Pb-Free) | 50 Units / Rail |
| MC14013BFELG | | 2000 Units / Tape & Reel |

[†]For information on tape and reel specifications, including part orientation and tape sizes, please refer to our Tape and Reel Packaging Specifications Brochure, BRD8011/D.

*NLV Prefix for Automotive and Other Applications Requiring Unique Site and Control Change Requirements; AEC-Q100 Qualified and PPAP Capable.

MC14013B

ELECTRICAL CHARACTERISTICS (Voltages Referenced to V_{SS})

| Characteristic | Symbol | V_{DD} Vdc | - 55°C | | 25°C | | | 125°C | | Unit | |
|---|-----------------------|-----------------|---|-------------------|-------------|-------------------------|-------------------|-------------|-----------------|-----------|-----|
| | | | Min | Max | Min | Typ ⁽²⁾ | Max | Min | Max | | |
| Output Voltage $V_{in} = V_{DD}$ or 0 $V_{in} = 0$ or V_{DD} | “0” Level V_{OL} | 5.0 | – | 0.05 | – | 0 | 0.05 | – | 0.05 | Vdc | |
| | | 10 | – | 0.05 | – | 0 | 0.05 | – | 0.05 | | |
| | | 15 | – | 0.05 | – | 0 | 0.05 | – | 0.05 | | |
| | “1” Level V_{OH} | 5.0 | 4.95 | – | 4.95 | 5.0 | – | 4.95 | – | | Vdc |
| | | 10 | 9.95 | – | 9.95 | 10 | – | 9.95 | – | | |
| | | 15 | 14.95 | – | 14.95 | 15 | – | 14.95 | – | | |
| Input Voltage $(V_O = 4.5$ or 0.5 Vdc) $(V_O = 9.0$ or 1.0 Vdc) $(V_O = 13.5$ or 1.5 Vdc) $(V_O = 0.5$ or 4.5 Vdc) $(V_O = 1.0$ or 9.0 Vdc) $(V_O = 1.5$ or 13.5 Vdc) | “0” Level V_{IL} | 5.0 | – | 1.5 | – | 2.25 | 1.5 | – | 1.5 | Vdc | |
| | | 10 | – | 3.0 | – | 4.50 | 3.0 | – | 3.0 | | |
| | | 15 | – | 4.0 | – | 6.75 | 4.0 | – | 4.0 | | |
| | “1” Level V_{IH} | 5.0 | 3.5 | – | 3.5 | 2.75 | – | 3.5 | – | Vdc | |
| | | 10 | 7.0 | – | 7.0 | 5.50 | – | 7.0 | – | | |
| | | 15 | 11 | – | 11 | 8.25 | – | 11 | – | | |
| Output Drive Current $(V_{OH} = 2.5$ Vdc) $(V_{OH} = 4.6$ Vdc) $(V_{OH} = 9.5$ Vdc) $(V_{OH} = 13.5$ Vdc) $(V_{OL} = 0.4$ Vdc) $(V_{OL} = 0.5$ Vdc) $(V_{OL} = 1.5$ Vdc) | Source I_{OH} | 5.0 | – 3.0 | – | – 2.4 | – 4.2 | – | – 1.7 | – | mAdc | |
| | | 5.0 | – 0.64 | – | – 0.51 | – 0.88 | – | – 0.36 | – | | |
| | | 10 | – 1.6 | – | – 1.3 | – 2.25 | – | – 0.9 | – | | |
| | | 15 | – 4.2 | – | – 3.4 | – 8.8 | – | – 2.4 | – | | |
| | Sink I_{OL} | 5.0 | 0.64 | – | 0.51 | 0.88 | – | 0.36 | – | mAdc | |
| | | 10 | 1.6 | – | 1.3 | 2.25 | – | 0.9 | – | | |
| 15 | | 4.2 | – | 3.4 | 8.8 | – | 2.4 | – | | | |
| Input Current | I_{in} | 15 | – | ± 0.1 | – | ± 0.00001 | ± 0.1 | – | ± 1.0 | μ Adc | |
| Input Capacitance $(V_{in} = 0)$ | C_{in} | – | – | – | – | 5.0 | 7.5 | – | – | pF | |
| Quiescent Current (Per Package) | I_{DD} | 5.0 10 15 | – – – | 1.0 2.0 4.0 | – – – | 0.002 0.004 0.006 | 1.0 2.0 4.0 | – – – | 30 60 120 | μ Adc | |
| Total Supply Current ^{(3) (4)} (Dynamic plus Quiescent, Per Package) $(C_L = 50$ pF on all outputs, all buffers switching) | I_T | 5.0 10 15 | $I_T = (0.75 \mu\text{A/kHz}) f + I_{DD}$ $I_T = (1.5 \mu\text{A/kHz}) f + I_{DD}$ $I_T = (2.3 \mu\text{A/kHz}) f + I_{DD}$ | | | | | | | μ Adc | |

2. Data labelled “Typ” is not to be used for design purposes but is intended as an indication of the IC’s potential performance.

3. The formulas given are for the typical characteristics only at 25°C.

4. To calculate total supply current at loads other than 50 pF:

$$I_T(C_L) = I_T(50 \text{ pF}) + (C_L - 50) Vfk$$

where: I_T is in μA (per package), C_L in pF, $V = (V_{DD} - V_{SS})$ in volts, f in kHz is input frequency, and $k = 0.002$.

MC14013B

SWITCHING CHARACTERISTICS ⁽⁵⁾ ($C_L = 50 \text{ pF}$, $T_A = 25^\circ\text{C}$)

| Characteristic | Symbol | V _{DD} | Min | Typ ⁽⁶⁾ | Max | Unit |
|--|--------------------------|---|---|--|---|---------------|
| Output Rise and Fall Time t_{TLH} , $t_{THL} = (1.5 \text{ ns/pF}) C_L + 25 \text{ ns}$ t_{TLH} , $t_{THL} = (0.75 \text{ ns/pF}) C_L + 12.5 \text{ ns}$ t_{TLH} , $t_{THL} = (0.55 \text{ ns/pF}) C_L + 9.5 \text{ ns}$ | t_{TLH} , t_{THL} | 5.0 10 15 | – – – | 100 50 40 | 200 100 80 | ns |
| Propagation Delay Time Clock to Q, \bar{Q} t_{PLH} , $t_{PHL} = (1.7 \text{ ns/pF}) C_L + 90 \text{ ns}$ t_{PLH} , $t_{PHL} = (0.66 \text{ ns/pF}) C_L + 42 \text{ ns}$ t_{PLH} , $t_{PHL} = (0.5 \text{ ns/pF}) C_L + 25 \text{ ns}$ Set to Q, \bar{Q} t_{PLH} , $t_{PHL} = (1.7 \text{ ns/pF}) C_L + 90 \text{ ns}$ t_{PLH} , $t_{PHL} = (0.66 \text{ ns/pF}) C_L + 42 \text{ ns}$ t_{PLH} , $t_{PHL} = (0.5 \text{ ns/pF}) C_L + 25 \text{ ns}$ Reset to Q, \bar{Q} t_{PLH} , $t_{PHL} = (1.7 \text{ ns/pF}) C_L + 265 \text{ ns}$ t_{PLH} , $t_{PHL} = (0.66 \text{ ns/pF}) C_L + 67 \text{ ns}$ t_{PLH} , $t_{PHL} = (0.5 \text{ ns/pF}) C_L + 50 \text{ ns}$ | t_{PLH} , t_{PHL} | 5.0 10 15 5.0 10 15 5.0 10 15 | – – – – – – – – – | 175 75 50 175 75 50 225 100 75 | 350 150 100 350 150 100 450 200 150 | ns |
| Setup Times ⁽⁷⁾ | t_{su} | 5.0 10 15 | 40 20 15 | 20 10 7.5 | – – – | ns |
| Hold Times ⁽⁷⁾ | t_h | 5.0 10 15 | 40 20 15 | 20 10 7.5 | – – – | ns |
| Clock Pulse Width | t_{WL} , t_{WH} | 5.0 10 15 | 250 100 70 | 125 50 35 | – – – | ns |
| Clock Pulse Frequency | f_{cl} | 5.0 10 15 | – – – | 4.0 10 14 | 2.0 5.0 7.0 | MHz |
| Clock Pulse Rise and Fall Time | t_{TLH} t_{THL} | 5.0 10 15 | – – – | – – – | 15 5.0 4.0 | μs |
| Set and Reset Pulse Width | t_{WL} , t_{WH} | 5.0 10 15 | 250 100 70 | 125 50 35 | – – – | ns |
| Removal Times Set Reset | t_{rem} | 5 10 15 5 10 15 | 80 45 35 50 30 25 | 0 5 5 –35 –10 –5 | – – – – – – | ns |

5. The formulas given are for the typical characteristics only at 25°C.

6. Data labelled "Typ" is not to be used for design purposes but is intended as an indication of the IC's potential performance.

7. Data must be valid for 250 ns with a 5 V supply, 100 ns with 10 V, and 70 ns with 15 V.

LOGIC DIAGRAM (1/2 of Device Shown)

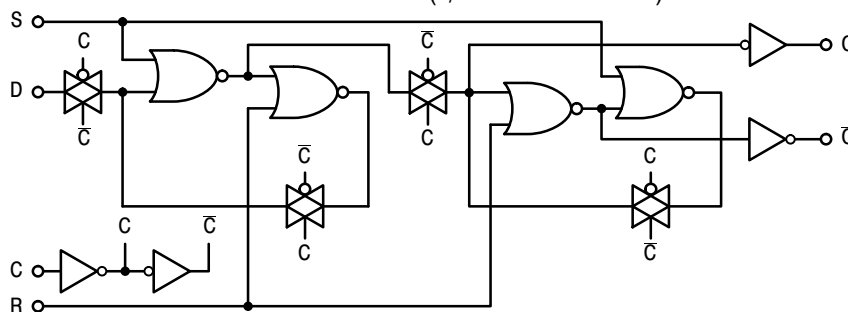

MC14013B

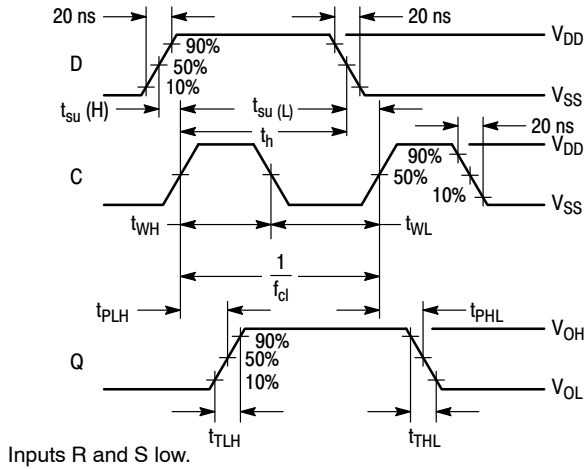

Figure 1. Dynamic Signal Waveforms (Data, Clock, and Output)

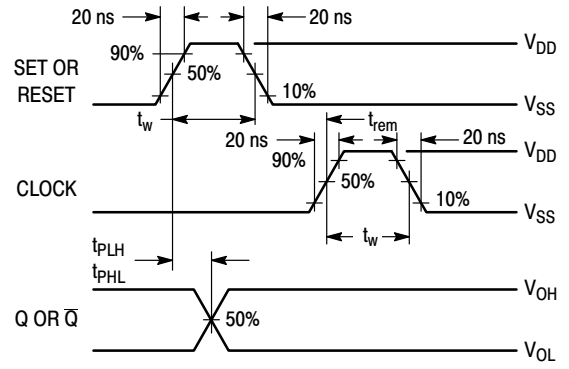
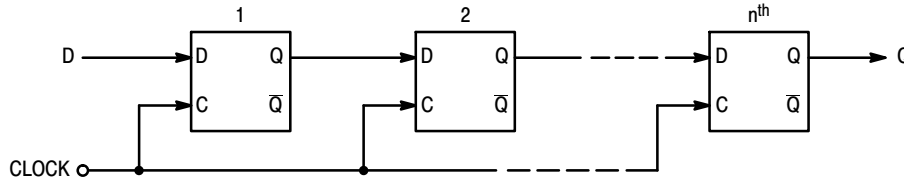

Figure 2. Dynamic Signal Waveforms (Set, Reset, Clock, and Output)

TYPICAL APPLICATIONS

n-STAGE SHIFT REGISTER



BINARY RIPPLE UP-COUNTER (Divide-by- 2^n)

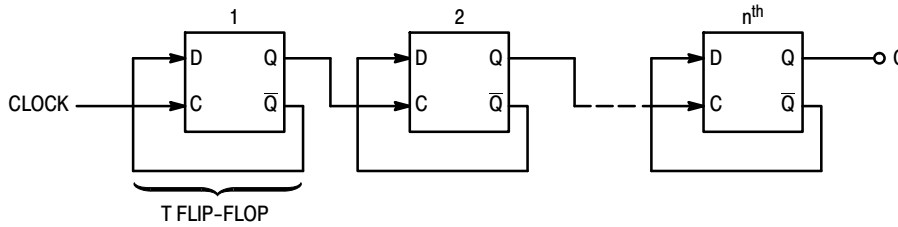

MODIFIED RING COUNTER (Divide-by-(n+1))

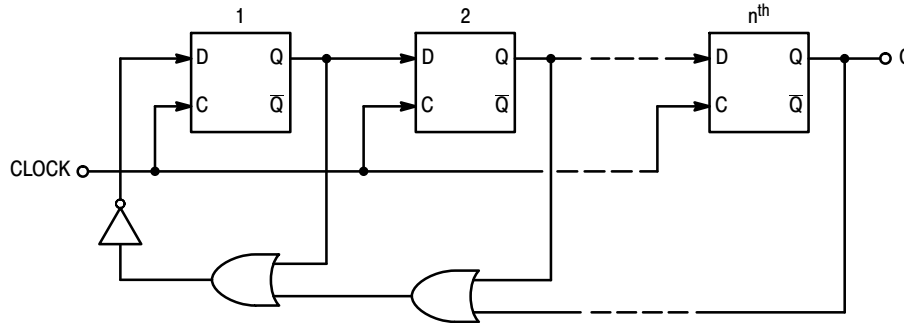

MC14013B

PACKAGE DIMENSIONS

PDIP-14
CASE 646-06
ISSUE P

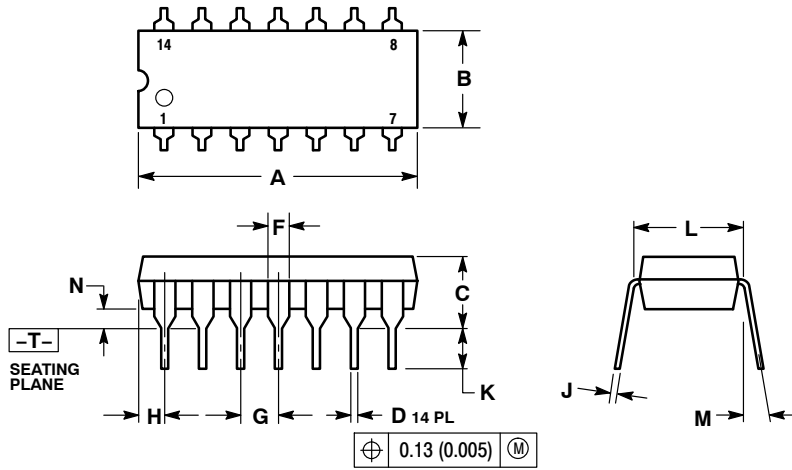

NOTES:

1. DIMENSIONING AND TOLERANCING PER ANSI Y14.5M, 1982.
2. CONTROLLING DIMENSION: INCH.
3. DIMENSION L TO CENTER OF LEADS WHEN FORMED PARALLEL.
4. DIMENSION B DOES NOT INCLUDE MOLD FLASH.
5. ROUNDED CORNERS OPTIONAL.

| DIM | INCHES | | MILLIMETERS | |
|-----|-----------|-------|-------------|-------|
| | MIN | MAX | MIN | MAX |
| A | 0.715 | 0.770 | 18.16 | 19.56 |
| B | 0.240 | 0.260 | 6.10 | 6.60 |
| C | 0.145 | 0.185 | 3.69 | 4.69 |
| D | 0.015 | 0.021 | 0.38 | 0.53 |
| F | 0.040 | 0.070 | 1.02 | 1.78 |
| G | 0.100 BSC | | 2.54 BSC | |
| H | 0.052 | 0.095 | 1.32 | 2.41 |
| J | 0.008 | 0.015 | 0.20 | 0.38 |
| K | 0.115 | 0.135 | 2.92 | 3.43 |
| L | 0.290 | 0.310 | 7.37 | 7.87 |
| M | --- | 10 ° | --- | 10 ° |
| N | 0.015 | 0.039 | 0.38 | 1.01 |

MC14013B

PACKAGE DIMENSIONS

SOIC-14 NB
CASE 751A-03
ISSUE K

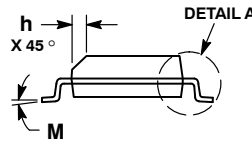
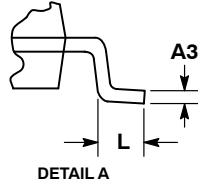
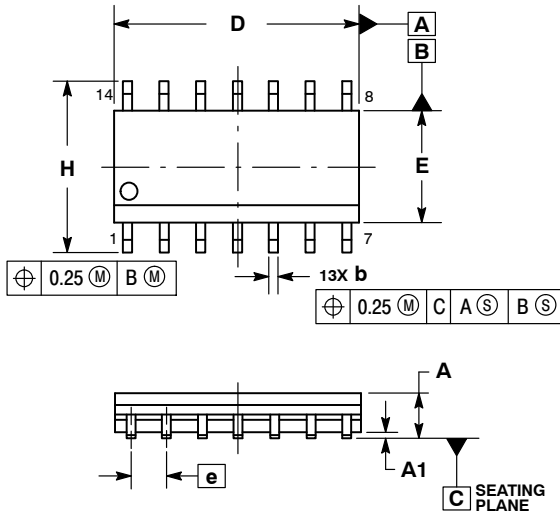

NOTES:

1. DIMENSIONING AND TOLERANCING PER ASME Y14.5M, 1994.
2. CONTROLLING DIMENSION: MILLIMETERS.
3. DIMENSION b DOES NOT INCLUDE DAMBAR PROTRUSION. ALLOWABLE PROTRUSION SHALL BE 0.13 TOTAL IN EXCESS OF AT MAXIMUM MATERIAL CONDITION.
4. DIMENSIONS D AND E DO NOT INCLUDE MOLD PROTRUSIONS.
5. MAXIMUM MOLD PROTRUSION 0.15 PER SIDE.

| DIM | MILLIMETERS | | INCHES | |
|-----|-------------|------|-----------|-------|
| | MIN | MAX | MIN | MAX |
| A | 1.35 | 1.75 | 0.054 | 0.068 |
| A1 | 0.10 | 0.25 | 0.004 | 0.010 |
| A3 | 0.19 | 0.25 | 0.008 | 0.010 |
| b | 0.35 | 0.49 | 0.014 | 0.019 |
| D | 8.55 | 8.75 | 0.337 | 0.344 |
| E | 3.80 | 4.00 | 0.150 | 0.157 |
| e | 1.27 BSC | | 0.050 BSC | |
| H | 5.80 | 6.20 | 0.228 | 0.244 |
| h | 0.25 | 0.50 | 0.010 | 0.019 |
| L | 0.40 | 1.25 | 0.016 | 0.049 |
| M | 0° | 7° | 0° | 7° |

SOLDERING FOOTPRINT*

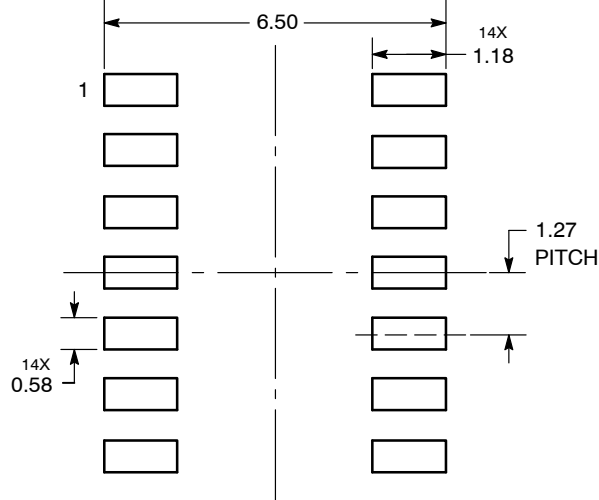

DIMENSIONS: MILLIMETERS

*For additional information on our Pb-Free strategy and soldering details, please download the ON Semiconductor Soldering and Mounting Techniques Reference Manual, SOLDERRM/D.

MC14013B

PACKAGE DIMENSIONS

SOEIAJ-14
CASE 965
ISSUE B

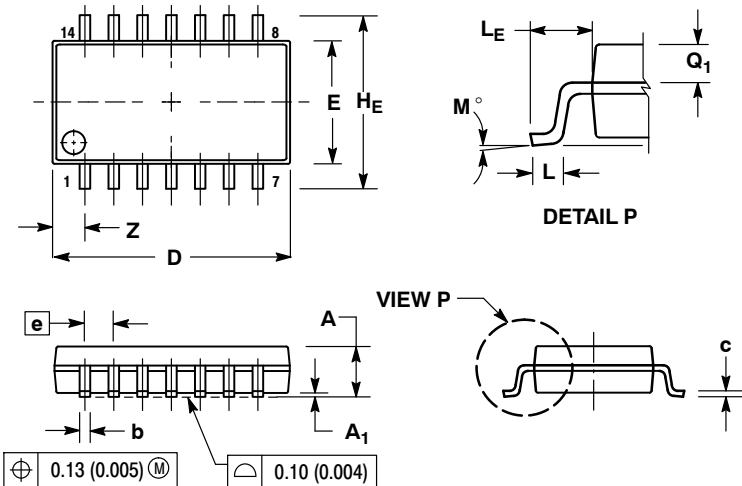

NOTES:

1. DIMENSIONING AND TOLERANCING PER ANSI Y14.5M, 1982.
2. CONTROLLING DIMENSION: MILLIMETER.
3. DIMENSIONS D AND E DO NOT INCLUDE MOLD FLASH OR PROTRUSIONS AND ARE MEASURED AT THE PARTING LINE. MOLD FLASH OR PROTRUSIONS SHALL NOT EXCEED 0.15 (0.006) PER SIDE.
4. TERMINAL NUMBERS ARE SHOWN FOR REFERENCE ONLY.
5. THE LEAD WIDTH DIMENSION (b) DOES NOT INCLUDE DAMBAR PROTRUSION. ALLOWABLE DAMBAR PROTRUSION SHALL BE 0.08 (0.003) TOTAL IN EXCESS OF THE LEAD WIDTH DIMENSION AT MAXIMUM MATERIAL CONDITION. DAMBAR CANNOT BE LOCATED ON THE LOWER RADIUS OR THE FOOT. MINIMUM SPACE BETWEEN PROTRUSIONS AND ADJACENT LEAD TO BE 0.46 (0.018).

| DIM | MILLIMETERS | | INCHES | |
|----------------|-------------|-------|-----------|-------|
| | MIN | MAX | MIN | MAX |
| A | --- | 2.05 | --- | 0.081 |
| A ₁ | 0.05 | 0.20 | 0.002 | 0.008 |
| b | 0.35 | 0.50 | 0.014 | 0.020 |
| c | 0.10 | 0.20 | 0.004 | 0.008 |
| D | 9.90 | 10.50 | 0.390 | 0.413 |
| E | 5.10 | 5.45 | 0.201 | 0.215 |
| e | 1.27 BSC | | 0.050 BSC | |
| H _E | 7.40 | 8.20 | 0.291 | 0.323 |
| L | 0.50 | 0.85 | 0.020 | 0.033 |
| L _E | 1.10 | 1.50 | 0.043 | 0.059 |
| M | 0° | 10° | 0° | 10° |
| Q ₁ | 0.70 | 0.90 | 0.028 | 0.035 |
| Z | --- | 1.42 | --- | 0.056 |

ON Semiconductor and are registered trademarks of Semiconductor Components Industries, LLC (SCILLC). SCILLC owns the rights to a number of patents, trademarks, copyrights, trade secrets, and other intellectual property. A listing of SCILLC's product/patent coverage may be accessed at www.onsemi.com/site/pdf/Patent-Marking.pdf. SCILLC reserves the right to make changes without further notice to any products herein. SCILLC makes no warranty, representation or guarantee regarding the suitability of its products for any particular purpose, nor does SCILLC assume any liability arising out of the application or use of any product or circuit, and specifically disclaims any and all liability, including without limitation special, consequential or incidental damages. "Typical" parameters which may be provided in SCILLC data sheets and/or specifications can and do vary in different applications and actual performance may vary over time. All operating parameters, including "Typicals" must be validated for each customer application by customer's technical experts. SCILLC does not convey any license under its patent rights nor the rights of others. SCILLC products are not designed, intended, or authorized for use as components in systems intended for surgical implant into the body, or other applications intended to support or sustain life, or for any other application in which the failure of the SCILLC product could create a situation where personal injury or death may occur. Should Buyer purchase or use SCILLC products for any such unintended or unauthorized application, Buyer shall indemnify and hold SCILLC and its officers, employees, subsidiaries, affiliates, and distributors harmless against all claims, costs, damages, and expenses, and reasonable attorney fees arising out of, directly or indirectly, any claim of personal injury or death associated with such unintended or unauthorized use, even if such claim alleges that SCILLC was negligent regarding the design or manufacture of the part. SCILLC is an Equal Opportunity/Affirmative Action Employer. This literature is subject to all applicable copyright laws and is not for resale in any manner.

PUBLICATION ORDERING INFORMATION

LITERATURE FULFILLMENT:
Literature Distribution Center for ON Semiconductor
P.O. Box 5163, Denver, Colorado 80217 USA
Phone: 303-675-2175 or 800-344-3860 Toll Free USA/Canada
Fax: 303-675-2176 or 800-344-3867 Toll Free USA/Canada
Email: orderlit@onsemi.com

N. American Technical Support: 800-282-9855 Toll Free
USA/Canada
Europe, Middle East and Africa Technical Support:
Phone: 421 33 790 2910
Japan Customer Focus Center
Phone: 81-3-5817-1050

ON Semiconductor Website: www.onsemi.com
Order Literature: <http://www.onsemi.com/orderlit>

For additional information, please contact your local Sales Representative