

Versatile Filtered Power Entry Module



- | Rated currents up to 6 A
- | Single or dual-fuse holder
- | Fuses Ø 6.3 x 32 mm Ø 5 x 20 mm
- | 2-pole rocker switch
- | General purpose application
- | Optional medical versions (B type)



Performance indicators

Attenuation performance



Rated current [A]



Approvals



The FN 380 power entry module combines an IEC inlet, a mains filter with a single or dual fuse holder and a 2-pole rocker switch. Choosing FN 380 product line brings you the rapid availability of a standard filter associated with the necessary safety acceptances. Standard IEC connector filters are a practical solution helping you to pass EMI system approval in a short time. A wide selection on amperage ratings, fuse options, mounting possibilities and filters for medical applications are designed to offer you the desired solution.

Features and benefits

- | Good conducted attenuation performance, based on chokes with high saturation resistance and excellent thermal behavior
- | Front or snap-in mounting
- | Single or dual-fuse holder
- | USA Ø 6.3 x 32 mm or EU Ø 5 x 20 mm fuses
- | 2-pole rocker switch
- | Custom-specific versions are available on request

Technical specifications

Maximum continuous operating voltage	250 VAC, 50/60 Hz
Operating frequency	50 to 400 Hz
Rated currents	2 to 6 A @ 40 °C max.
High potential test voltage	P → PE 2000 VAC for 2 sec (standard types) P → N 760 VAC for 2 sec P → PE 2500 VAC for 2 sec (B types)
Protection category	IP40 according to IEC 60529
Temperature range (operation and storage)	-25 °C to +85 °C (25/85/21)
Design corresponding to	UL 1283, CSA 22.2 No. 8 1986, IEC/EN 60939
Flammability corresponding to	UL 94 V-2 or better
MTBF @ 40°C/230V (Mil-HB-217F)	550,000 hours
Function	2-pole, dark not illuminated Marking I - 0
Electrical specifications	Inrush current 51 A 6,000 on-off operations according to UL 1054, TV 5 10,000 on-off operations according to ENEC
Mechanical life	50,000 cycles
Switch ratings	
Europe (ENEC)	6 A (4 A), 250 VAC*
USA (UL)	6A, 125 VAC; 4 A, 250 VAC; 1/10 HP
Canada (CSA)	6 A, 125 VAC; 4 A, 250 VAC; 1/10 HP
Output connections	Blade terminals acc. DIN 46 244-A4.8-0.8 (do not connect by soldering)

* Value in () relates to the inductive current charge: $\cos \varphi = 0.65$

Typical applications

- | Portable electrical and electronic equipment
- | Consumer goods
- | EDP and office equipment
- | Single-phase power supplies, switch-mode power supplies
- | Test and measurement equipment
- | Medical equipment

Typical electrical schematic

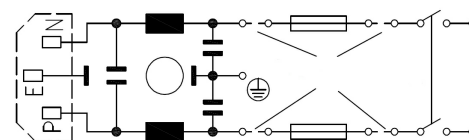











Filter selection table

Filter*	Rated current @ 40 °C (25 °C)	Leakage current** @ 230 VAC/50 Hz	Inductance L	Capacitance		Resistance R	Output connections	Fuses***	Weight
	[A]	[µA]	[mH]	Cx [nF]	Cy [nF]	[kΩ]		[Qty]	[g]
FN 380-2-2.	2 (2.4)	373	0.70	47	2.2		13	1	55
FN 380-4-2.	4 (4.8)	373	0.30	47	2.2		13	1	55
FN 380-6-2.	6 (7.2)	373	0.18	47	2.2		13	1	55
FN 382-2-2.	2 (2.4)	373	0.70	47	2.2		13	2	55
FN 382-4-2.	4 (4.8)	373	0.30	47	2.2		13	2	55
FN 382-6-2.	6 (7.2)	373	0.18	47	2.2		13	2	55
FN 385-2-2.	2 (2.4)	373	2.00	47	2.2		13	2	65
FN 385-4-2.	4 (4.8)	373	0.80	47	2.2		13	2	65
FN 385-6-2.	6 (7.2)	373	0.50	47	2.2		13	2	65
FN 388-2-2.	2 (2.4)	373	0.70	47	2.2		13	2	60
FN 388-4-2.	4 (4.8)	373	0.30	47	2.2		13	2	60
FN 388-6-2.	6 (7.2)	373	0.18	47	2.2		13	2	60
FN 389-2-2.	2 (2.4)	373	2.00	47	2.2		13	2	70
FN 389-4-2.	4 (4.8)	373	0.80	47	2.2		13	2	70
FN 389-6-2.	6 (7.2)	373	0.50	47	2.2		13	2	70
FN 382B-2-2.	2 (2.4)	2	0.70	47		1000	13	2	55
FN 382B-4-2.	4 (4.8)	2	0.30	47		1000	13	2	55
FN 382B-6-2.	6 (7.2)	2	0.18	47		1000	13	2	55
FN 389B-2-2.	2 (2.4)	2	2.00	47		1000	13	2	70
FN 389B-4-2.	4 (4.8)	2	0.80	47		1000	13	2	70
FN 389B-6-2.	6 (7.2)	2	0.50	47		1000	13	2	70

* Select the requested fuse holder for fuse EUR-1 or USA-1.

** Maximum leakage under normal operating conditions. Note: if the neutral line is interrupted, worst case leakage could reach twice this level.

*** Filters are delivered without fuse.

Product selector	
FN 38xx-y-zz	
	1: Fuse Ø5 x 20mm (FUSE-H EUR-1)
	2: Fuse Ø6.3 x 32mm (FUSE-H USA-1)
	2: Rocker switch, 2-pole, dark not illuminated
	2 to 6: Rated current
	Blank: Standard version
	B: Medical version (with bleed resistor and without Y2-capacitor)
	0: Snap-in version, single-fuse, standard performance
	2: Snap-in version, dual-fuse, standard performance
	5: Snap-in version, dual-fuse, high performance
	8: Flange mounting version, dual-fuse, standard performance
	9: Flange mounting version, dual-fuse, high performance

Typical filter attenuation

Per CISPR 17; A = 50 Ω/50 Ω sym; B = 50 Ω/50 Ω asym; C = 0.1 Ω/100 Ω sym; D = 100 Ω/0.1 Ω sym

FN 380 / FN 382 / FN 388

FN 385 / FN 389

6A type only

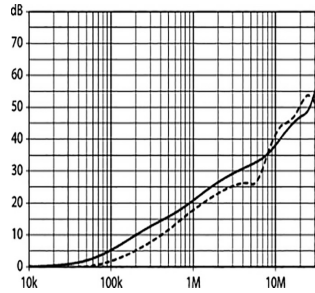
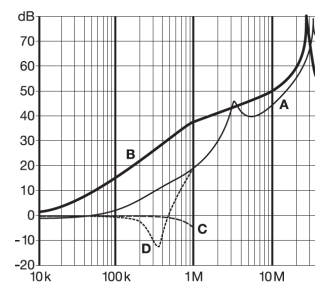
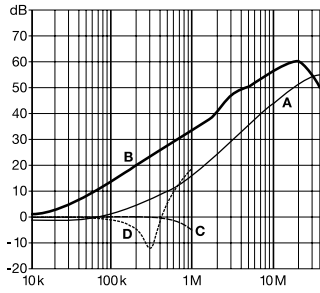

Mechanical data

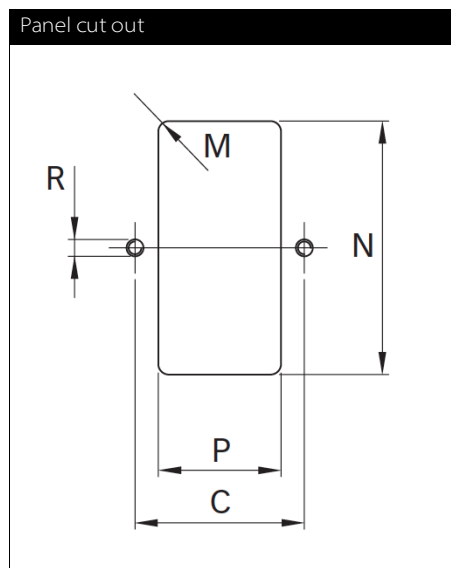
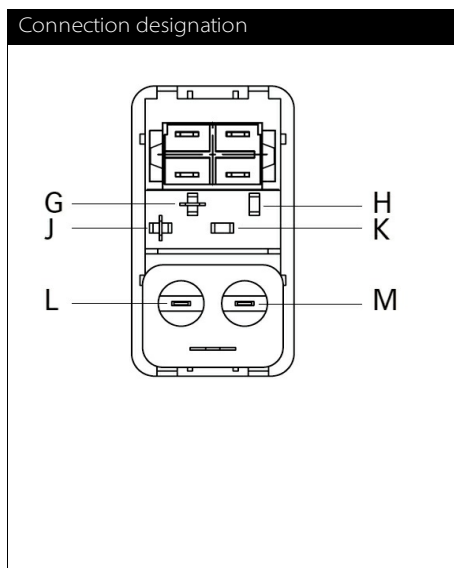
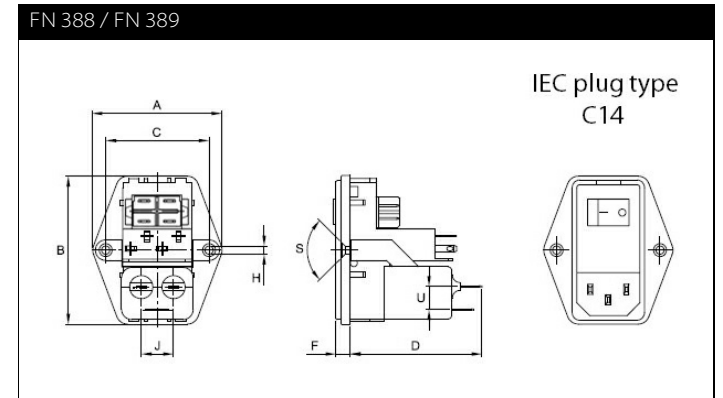
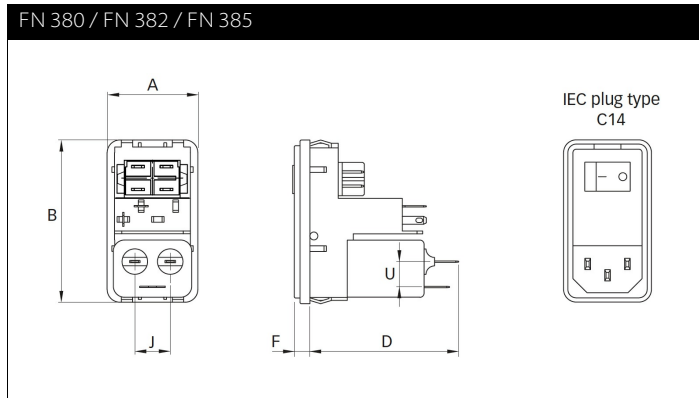

Dimensions

	FN 380	FN 382	FN 385	FN 388	FN 389	Tolerances
A	32	32	32	50	50	±0.3
B	58	58	58	58	58	±0.3
C				40	40	±0.1
D	51	51	61	51	61	
F	5.5	5.5	5.5	5.5	5.5	
H				Ø 3.3	Ø 3.3	
J	12.5	12.5	12.5	12.5	12.5	
M	R ≤ 2	R ≤ 2	R ≤ 2	R ≤ 2	R ≤ 2	±0.1
N	55.9*/56.2**	55.9*/56.2**	55.9*/56.2**	55.9*/56.2**	55.9*/56.2**	+0.2/-0
P	28.5	28.5	28.5	28.5	28.5	+0.2/-0
R				M3	M3	
S				90°	90°	
U	9	9	9	9	9	

* For a back panel thickness between 0.8 and 2.0 mm

** For a back panel thickness between 2.1 and 3.2 mm

All dimensions in mm; 1 inch = 25.4 mm

Tolerances according: ISO 2768-m / EN 22768-m

Please visit www.schaffner.com to find more details on filter connectors.



Headquarters, global innovation and development center

Switzerland

Schaffner Group

Nordstrasse 11
4542 Luterbach
T +41 32 6816 626
F +41 32 6816 630
info@schaffner.com
<http://www.schaffner.com>



Sales and application centers

China

Schaffner EMC Ltd. Shanghai

T20-3, No 565 Chuangye Road
Pudong New Area
201201 Shanghai
T +86 21 3813 9500
F +86 21 3813 9501 / 02
cschina@schaffner.com
<http://www.schaffner.com.cn/>

Finland

Schaffner Oy

Sauvonrinne 19 H
08500 Lohja
T +358 19 35 72 71
finlandsales@schaffner.com

France

Schaffner EMC S.A.S.

112 Quai de Bezons
Boîte postale 133
95100 Argenteuil
T +33 1 34 34 30 60
F +33 1 39 47 02 28
francesales@schaffner.com

Germany

Schaffner Deutschland GmbH

Schoemperlenstrasse 12B
76185 Karlsruhe
T +49 721 56910
F +49 721 569110
germanysales@schaffner.com

Italy

Schaffner EMC S.r.l.

Via Galileo Galilei 47
20092 Cinisello Balsamo (MI)
T +39 02 66 04 30 45 /47
F +39 02 61 23 943
italysales@schaffner.com

Japan

Schaffner EMC K.K.

1-32-12, Kamiyama, Setagaya-ku
7F Mitsui-seimei Sangenjaya Bldg.
154-0011 Tokyo
T +81 3 5712 3650
F +81 3 5712 3651
japansales@schaffner.com
<http://www.schaffner.jp>

Singapore

Schaffner EMC Pte Ltd.

Blk 3015A Ubi Road 1
05-09 Kampong Ubi Industrial Estate
408705 Singapore
T +65 6377 3283
F +65 6377 3281
singaporesales@schaffner.com

Spain

Schaffner EMC España

Calle Caléndula 93, Miniparc III, Edificio E,
Alcobendas
Miniparc III, Edificio E
El Soto de la Moraleja
Alcobendas
28109 Madrid
M +34 618 176 133
T +34 917 912 900
F +34 917 912 901
spainsales@schaffner.com

Sweden

Schaffner EMC AB

Turebergstorg 1, 6
19147 Sollentuna
T +46 8 5792 1121 / 22
F +46 8 92 96 90
swedensales@schaffner.com

Switzerland

Schaffner EMV AG

Nordstrasse 11
4542 Luterbach
T +41 32 681 66 26
F +41 32 681 66 41
switzerlandsales@schaffner.com

Taiwan R.O.C.

Schaffner EMV Ltd.

6 Floor, No. 413
114 Neihu District Taipei City
T +886 2 87525050
F +886 2 87518086
taiwansales@schaffner.com

Thailand

Schaffner EMC Co. Ltd.

Northern Region Industrial Estate
67 Moo 4 Tambon Ban Klang
Amphur Muangng P.O. Box 14
51000 Lamphun
T +66 53 58 11 04
F +66 53 58 10 19
thailandsales@schaffner.com

UK

Schaffner Ltd.

Wokingham
RG41 2PL Berkshire
T +44 118 9770070
F +44 118 9792969
uksales@schaffner.com
<http://www.schaffner.uk.com>

USA

Schaffner EMC Inc.

52 Mayfield Avenue
08837 Edison, New Jersey
T +1 800 367 5566
T +1 732 225 9533
F +1 732 225 4789
usasales@schaffner.com
<http://www.schaffner.com/us>

Schaffner MTC LLC

6722 Thirlane Road
24019 Roanoke, Virginia
T +1 276 228 7943
F +1 276 228 7953
<http://www.schaffner-mtc.com>

Schaffner Trencos LLC

2550 Brookpark Road
44134 Cleveland, Ohio
T +1 216 741 5282
F +1 216 741 4860
<http://schaffner-trencos.com>

To find your local partner within Schaffner's global network: www.schaffner.com

© 2015 Schaffner Group

The content of this document has been carefully checked and understood. However, neither Schaffner nor its subsidiaries assume any liability whatsoever for any errors or inaccuracies of this document and the consequences thereof. Published specifications are subject to change without notice. Product suitability for any area of application must ultimately be determined by the customer. In all cases, products must never be operated outside their published specifications. Schaffner does not guarantee the availability of all published products. This disclaimer shall be governed by substantive Swiss law and resulting disputes shall be settled by the courts at the place of business of Schaffner Holding AG. Latest publications and a complete disclaimer can be downloaded from the Schaffner website. All trademarks recognized.